

ASSEMBLY DRAWING

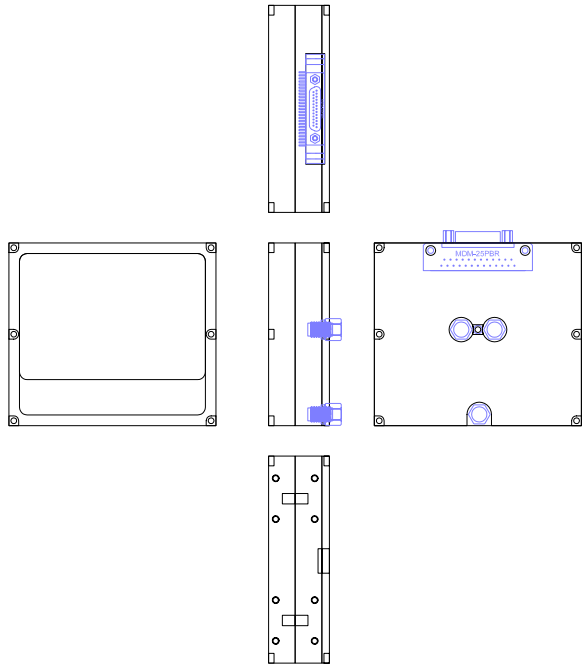

TOP LID

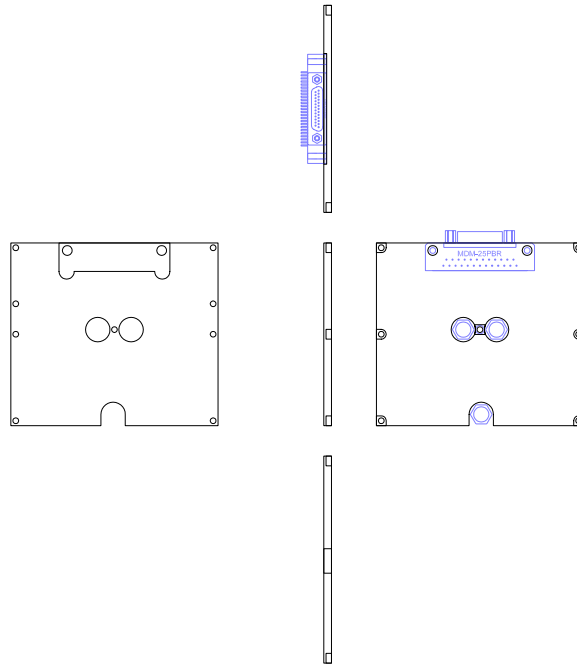

NATIONAL RADIO ASTRONOMY OBSERVATORY
K-Band Focal Plane Array Project
Integrated Downconverter Module #2

Matthew A. Morgan
2/16/2008

MATERIAL: Aluminum
Sulfate Nickel Plate per MIL-P-26074B, 5 micro-inches
Gold Plate per MIL-G-45204C, Type III, Class 0, 30 micro-inches

BOTTOM LID

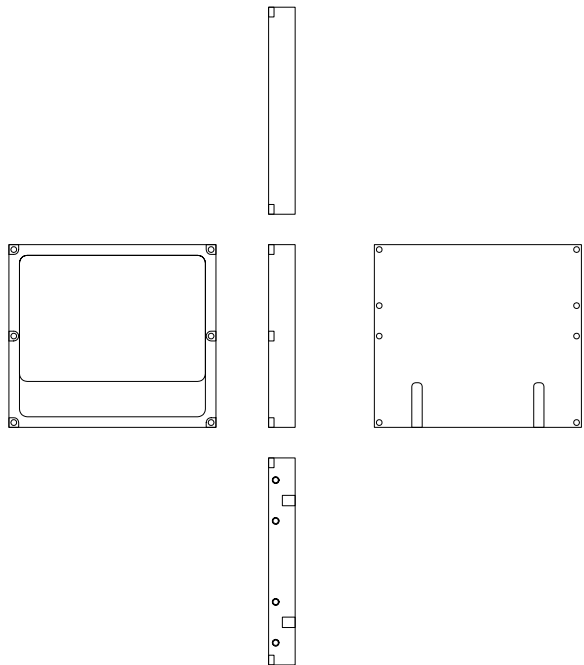

MMIC BLOCK

