

## Schottky Receiver measurements of Holography horn-lens combination.

G. A. Ediss and J. Crabtree  
2008-10-09

The following plots show the results (far field) of near field measurements made with the NSI scanner at the NA FEIC (red lines) compared to Far field measurements made by Srikanth and Crady using the Green Bank far field system (Blue lines). Both sets of measurements were made at 104.02 GHz. The cross pol rotation angle was determined by finding the angle with minimum on axis signal. As the Green Bank results are not normalized to 0 dB the NSI results have been shifted to the same position and maximum amplitude. The NA FEIC measurements are all single Z distance measurements, so the plots may include some effects due to reflections.

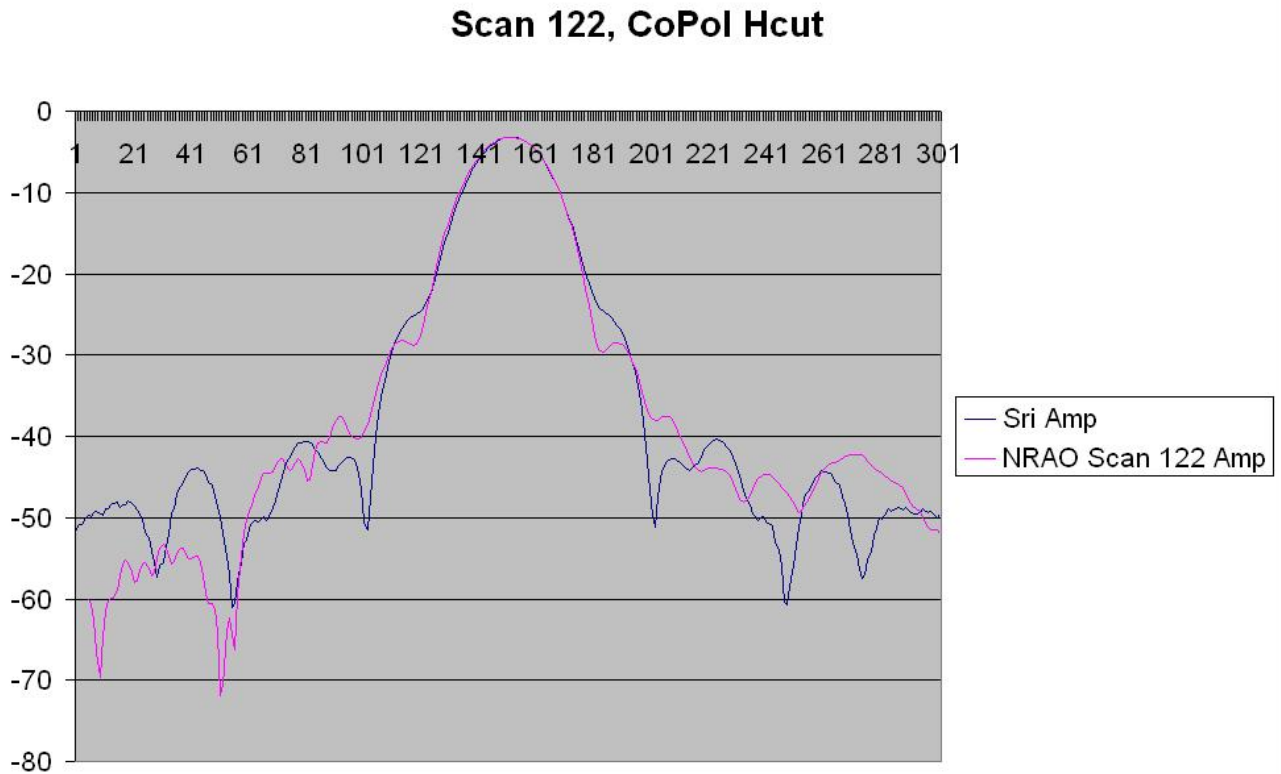

Figure 1 H plane.

### Scan 122, CoPol Vcut

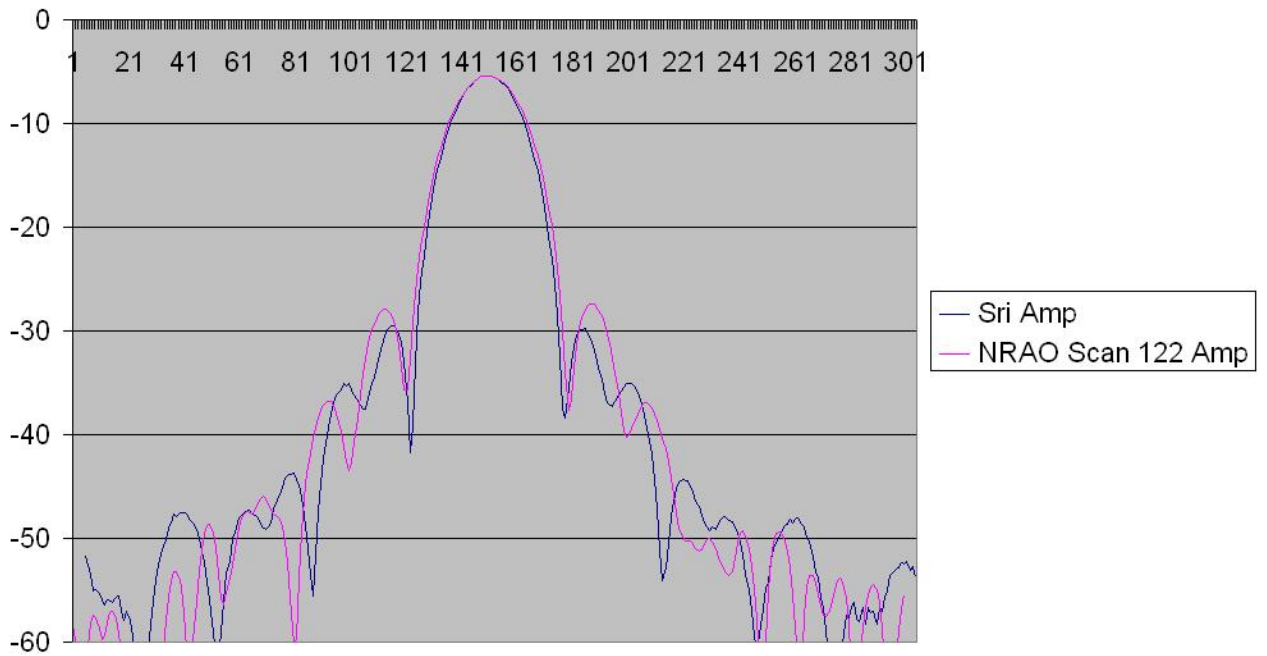

Figure 2 E plane.

Scan 122, CoPol Vcut (after rotating FF 45 degrees)

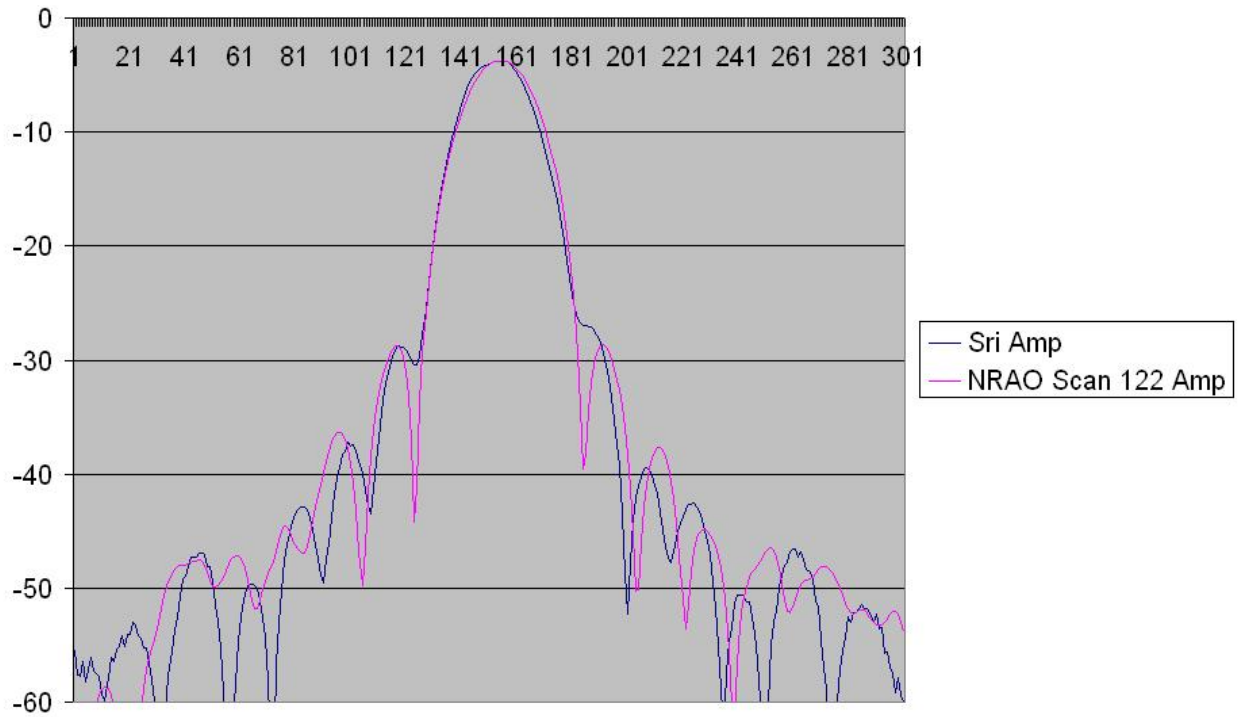

Figure 3 Co-polar diagonal cut.

scan 123, Xpol Vcut (after rotating FF 45 degrees)

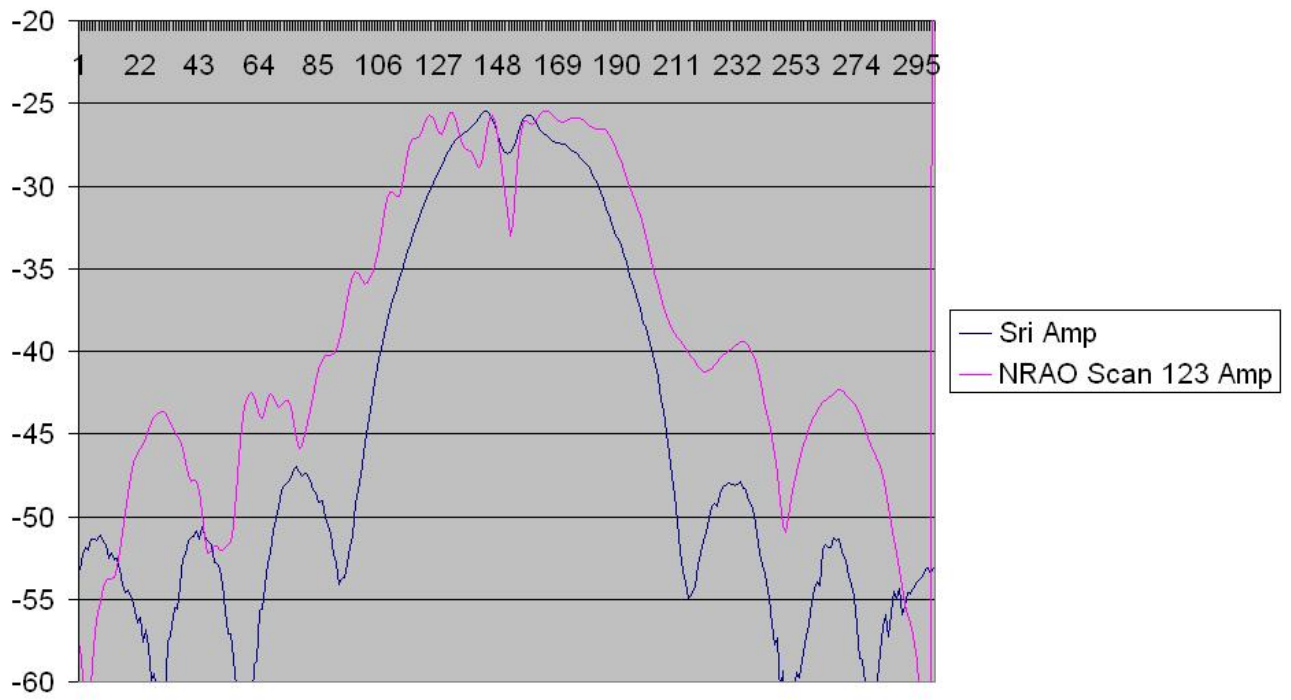

Figure 4 Cross polar diagonal cut.

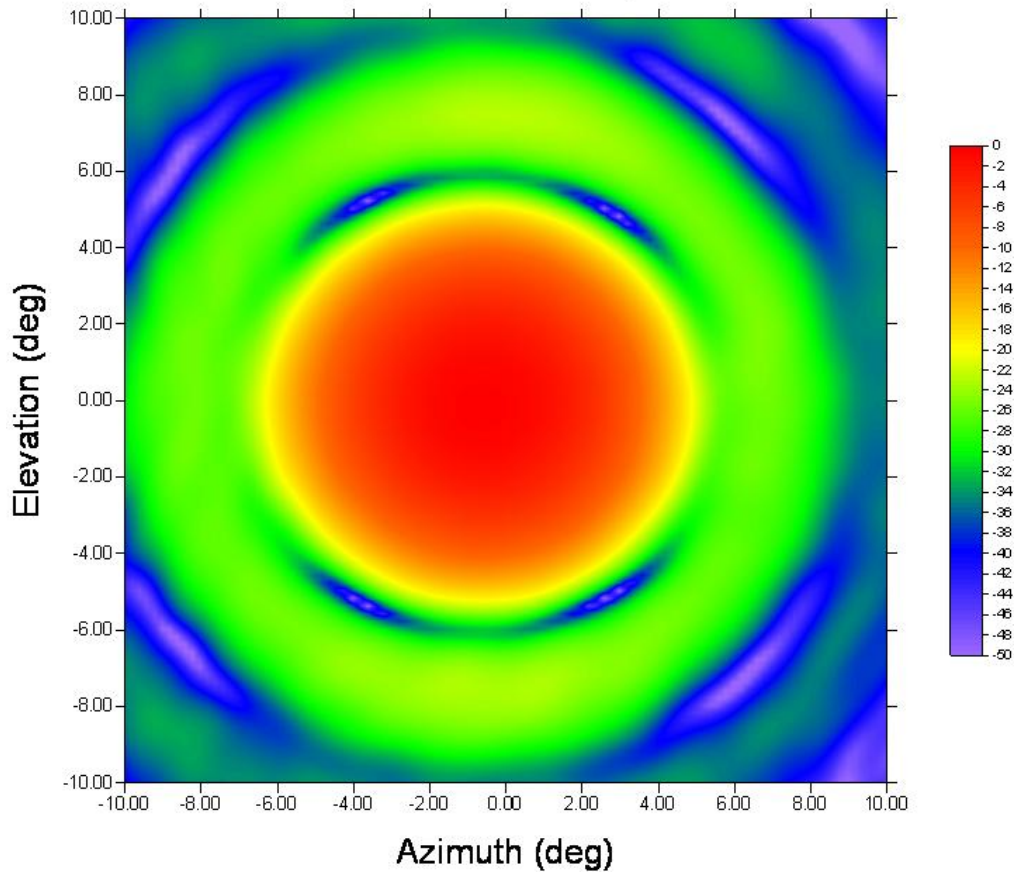
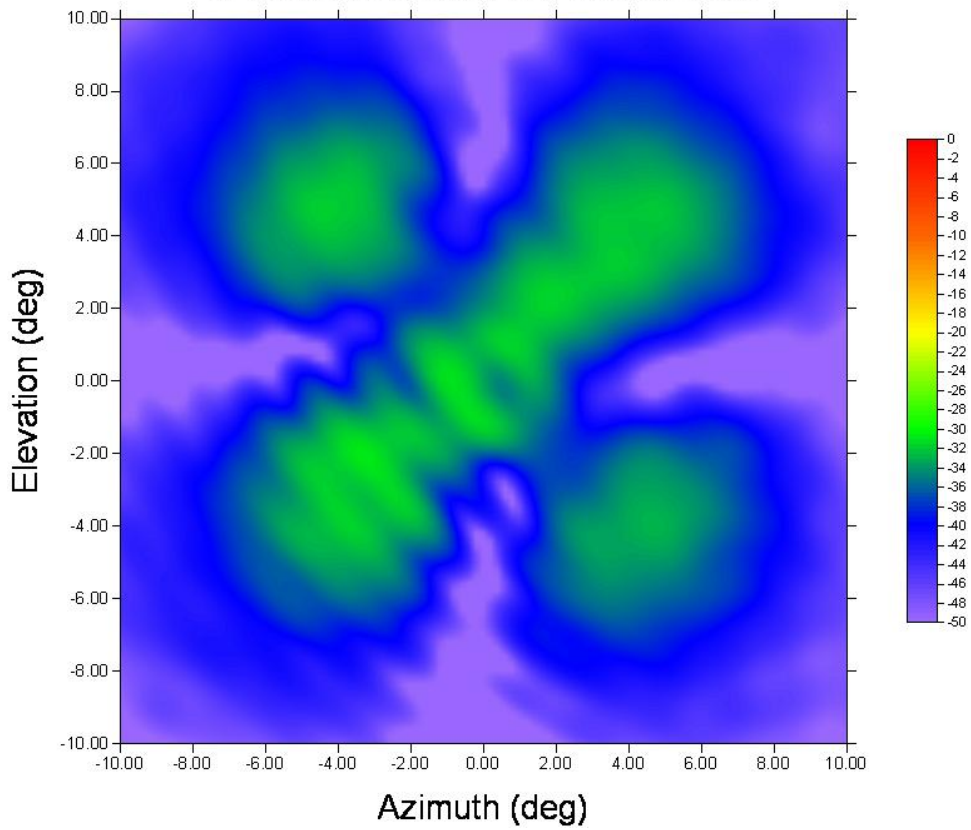
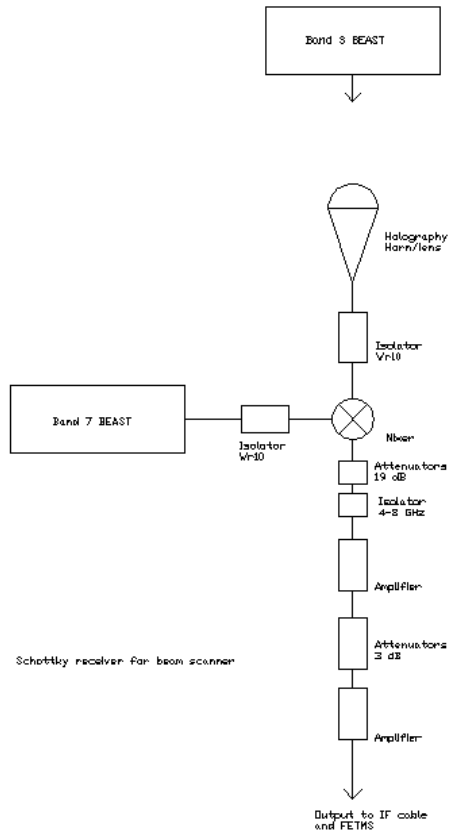

Figure 5 Far field transform of NSI near field scan.



**Figure 6 Far field transform of cross pol scan (normalized to co-pol).**

A block diagram of the Schottky receiver is given in figure 7.



**Figure 7 Block diagram of receiver.**